













Machine	Explode	Code	Description
CU620 - Electric Fryer Single - 3kW 8Ltr	1		Apron
CU620 - Electric Fryer Single - 3kW 8Ltr	2		Apron Back Seal
CU620 - Electric Fryer Single - 3kW 8Ltr	3		Foot Plate
CU620 - Electric Fryer Single - 3kW 8Ltr	4	AS337	Black Rubber Feet (set 4)
CU620 - Electric Fryer Single - 3kW 8Ltr	5		Oil Pan
CU620 - Electric Fryer Single - 3kW 8Ltr	6		Oil Drain Pipe
CU620 - Electric Fryer Single - 3kW 8Ltr	7		Oil Drain Valve
CU620 - Electric Fryer Single - 3kW 8Ltr	8		Left / Right Support
CU620 - Electric Fryer Single - 3kW 8Ltr	9		Dowel
CU620 - Electric Fryer Single - 3kW 8Ltr	10		Hoarding
CU620 - Electric Fryer Single - 3kW 8Ltr	11		Floor
CU620 - Electric Fryer Single - 3kW 8Ltr	12		Upper Circumference
CU620 - Electric Fryer Single - 3kW 8Ltr	13		Patch
CU620 - Electric Fryer Single - 3kW 8Ltr	14		Electric Box Hoarding
CU620 - Electric Fryer Single - 3kW 8Ltr	15		Side Panel for Electric Box
CU620 - Electric Fryer Single - 3kW 8Ltr	16		Side Panel
CU620 - Electric Fryer Single - 3kW 8Ltr	17		Sealing Plate
CU620 - Electric Fryer Single - 3kW 8Ltr	18	AS583	Heater
CU620 - Electric Fryer Single - 3kW 8Ltr	19		Rubber Sleeve
CU620 - Electric Fryer Single - 3kW 8Ltr	20		Basket Hanging Pole
CU620 - Electric Fryer Single - 3kW 8Ltr	21	AS333	Switch
CU620 - Electric Fryer Single - 3kW 8Ltr	22	AS344	Knob
CU620 - Electric Fryer Single - 3kW 8Ltr	23	AS332	Indicator Light
CU620 - Electric Fryer Single - 3kW 8Ltr	24		Left / Right Stiffening Plate
CU620 - Electric Fryer Single - 3kW 8Ltr	25	AS341	Travel Switch
CU620 - Electric Fryer Single - 3kW 8Ltr	26		Spring Plunger
CU620 - Electric Fryer Single - 3kW 8Ltr	27		Flat Net
CU620 - Electric Fryer Single - 3kW 8Ltr	28	AS324	Handle
CU620 - Electric Fryer Single - 3kW 8Ltr	29	AS586	Cover
CU620 - Electric Fryer Single - 3kW 8Ltr	30	AS335	Hi-Limit / Temperature Limiter
CU620 - Electric Fryer Single - 3kW 8Ltr	31	AT583	Circuit Board
CU620 - Electric Fryer Single - 3kW 8Ltr	32	AS327	EGO Thermostat
CU620 - Electric Fryer Single - 3kW 8Ltr	33	AS588	Basket
CU620 - Electric Fryer Single - 3kW 8Ltr	34		Cylinder Retainer Plate
CU620 - Electric Fryer Single - 3kW 8Ltr	35		Oil Cylinder Butt Weld

Circuit Diagram

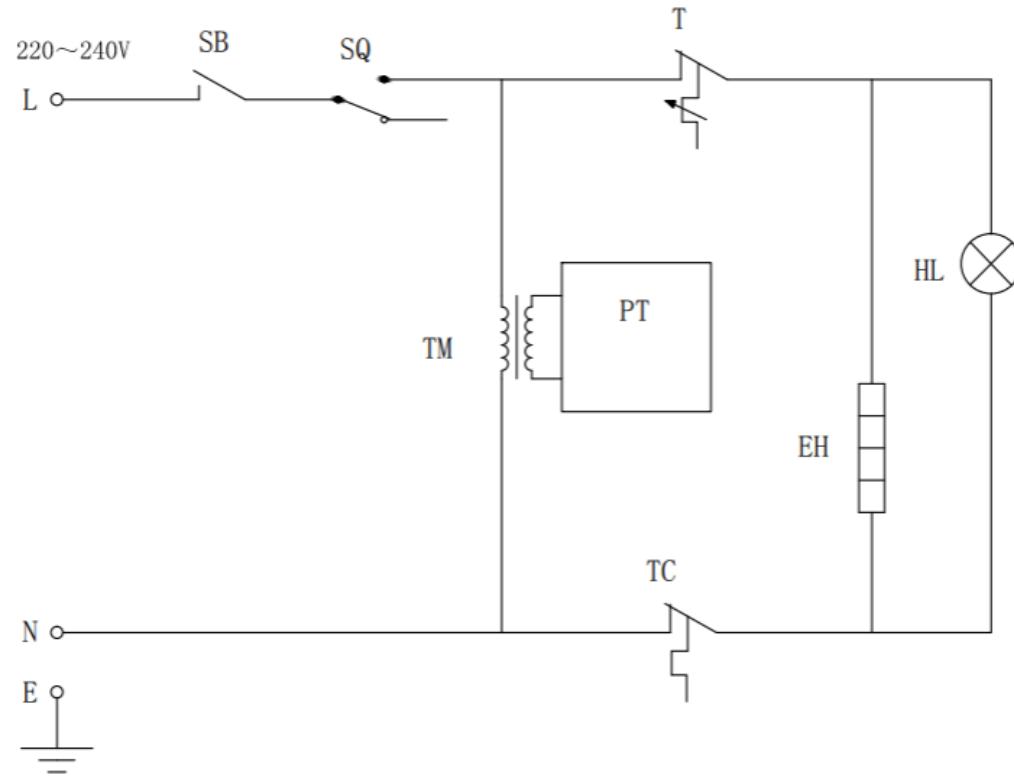

NO.	Code	Description
1	/	Wire of plug
2	SB	Power Switch
3	SQ	Micro Switch
4	TC	Hi-Limit
5	T	Thermostat
6	HL	Heating indicator light
7	EH	Heater
8	TM	Transformer
9	PT	Timer